

■ Specifications(规格) :

- Voltage rating(额定电压) : 125V AC / DC
- Current rating(额定电流) : 4A AC / DC
- Withstanding voltage(耐压值) : 1000V AC/minute
- Temperature range(工作温度) : -25°C~+85°C
- Insulation resistance(绝缘电阻) : ≥1000MΩ
- Contact resistance(接触电阻) : ≤10mΩ
- After environmental testing(环境测试后) : ≤20mΩ

■ Housing(胶壳)

- Part No. (料号) : A2013H
- Poles (PIN数) : 02-15
- Material (材质) : Nylon 66 (尼龙66) UL 94V-0
- Suitable HLB A2013T Series Terminal(匹配A2013T系列端子)
- Mates With HLB A2013 Series Wafer (匹配A2013系列针座)
- Q'ty (数量) : 1,000Pcs/Bag/每袋 (1,000Pcs)

Poles	Part No	Dimensions (mm)	
		A	B
2	A2013H -02P	2.00	6.00
3	A2013H -03P	4.00	8.00
4	A2013H -04P	6.00	10.00
5	A2013H -05P	8.00	12.00
6	A2013H -06P	10.00	14.00
7	A2013H -07P	12.00	16.00
8	A2013H -08P	14.00	18.00
9	A2013H -09P	16.00	20.00
10	A2013H -10P	18.00	22.00
11	A2013H -11P	20.00	24.00
12	A2013H -12P	22.00	26.00
13	A2013H -13P	24.00	28.00
14	A2013H -14P	26.00	30.00
15	A2013H -15P	28.00	32.00

							GENERAL TOLERANCE X ±0.30 .XX ±0.20 .XXX ±0.10				东莞市翰皓精密电子有限公司 Dongguan HanHao Precision Electronics Co.,Ltd				PART NO. A2013H-XX											
							APPROVAL Smark				CHECK Yu wei				DRAWN Liu Yan				DATA 2011/05/22							
							PROJECT 				UNIT mm				SCALE 1:1				NUMBER 8				REV B			
2011/05/22	A	B		Modify frame format	Jova	Jova Lau																				
DATE	OLD REV	NEW REV	ECN	DESCRIPTION	CHECK	APPROVAL																				

RoHS  Lead-free

■ SPECIFICATIONS

- Voltage rating : 125V AC, DC
- Current rating : 4A AC,DC.
- Withstanding voltage : 1000V AC/minute
- Insulation resistance : 1000MΩ min.
- Temperature range : - 25° ~ + 85°
- Contact resistance : Initial value/10mΩ max.
- After environmental testing/20mΩ max.

■ TERMINAL

- Part No.:A2013T
- Applicable Wire: AWG#22-26
- Material: Phosphor Bronze
- Q'ty: 10000 pcs/reel

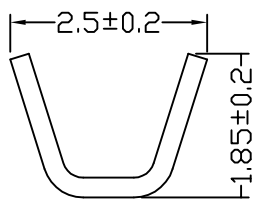
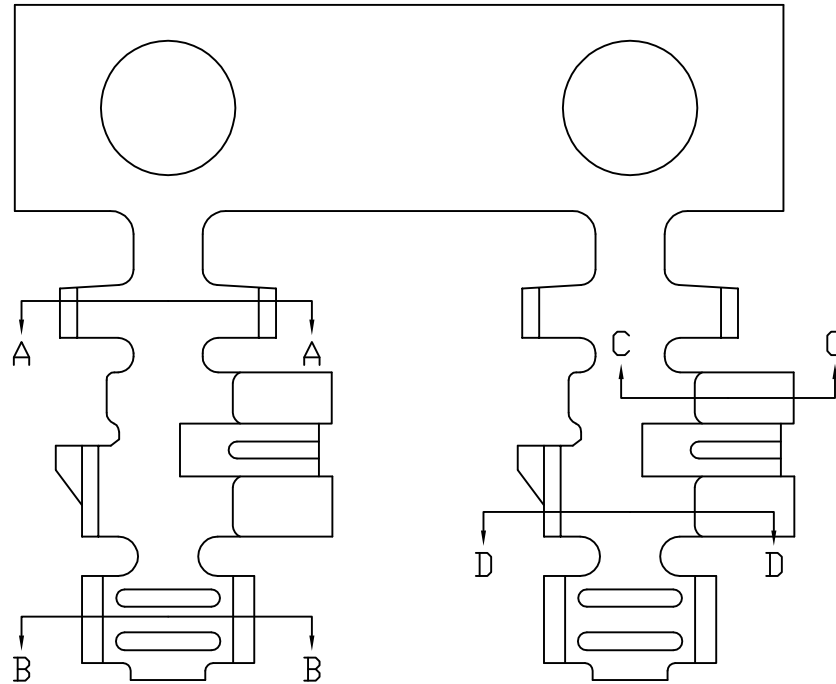
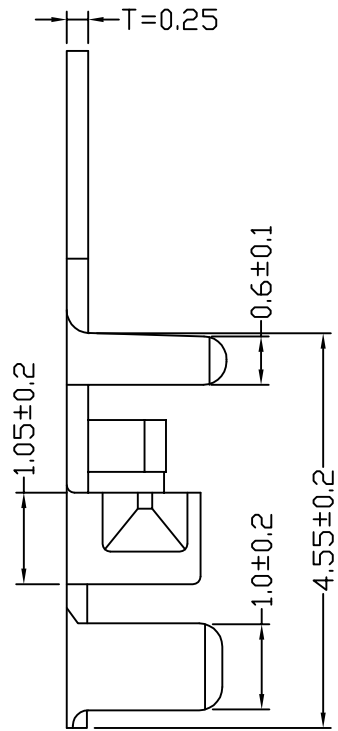

Section: A-A

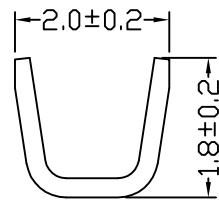

Section: B-B

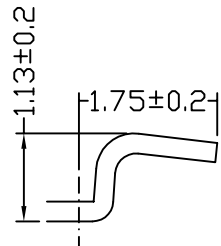

Section: C-C

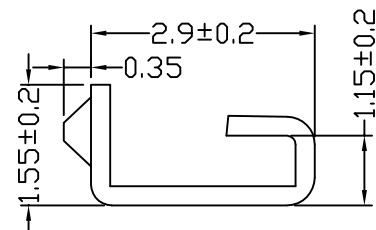

Section: D-D

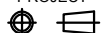
							GENERAL TOLERANCE		东莞市翰皓精密电子有限公司				PART NO. A2013T			
							X ±0.30		Dongguan HanHao Precision Electronics Co.,Ltd				TITLE			
							.XX ±0.20		APPROVAL		CHECK		DRAWN		DATA	
							.XXX ±0.10						Jova		2007/05/03	
							PROJECT						UNIT		SCALE	
													MM		1:1	
							2013/08/23		B		C		Modify drawing frame format		Jova	
							DATE		OLD REV		NEW REV		ECN		DESCRIPTION	
													NUMBER		REV	
													A-068		B	

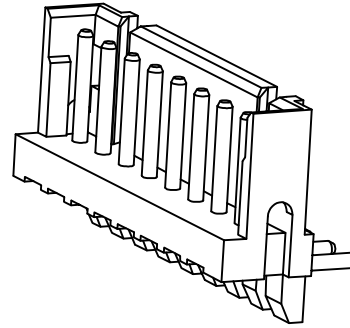
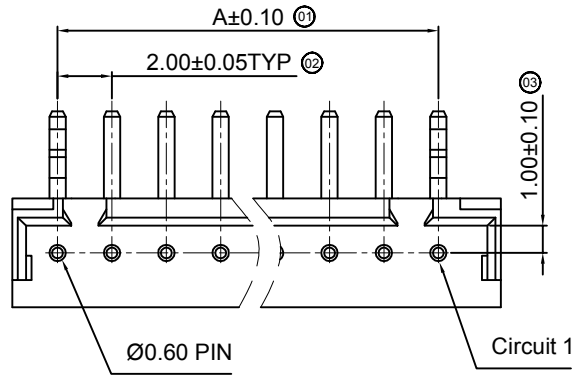

■ Specifications :

- Voltage rating: 125V AC / DC
- Current rating: 3A AC / DC
- Withstanding voltage: 1000V AC/minute
- Temperature range: -25°C~+85°C
- Insulation resistance: ≥1000MΩ
- Contact resistance: ≤10mΩ
- After environmental testing: ≤20mΩ
- Mark "*" Indicate Dimensions Need To Controlled In Emphasis

- ① Series No.
- ② Category: A2013WR-XX
- ③ Welding Way: DIP ; SMT
- ④ Material: PA66 94V-0
- ⑤ Plating Category: Gold Plated Contact
 - All Gold-Plated
 - Gold Flash 2u" 3u"
 - 5u" 10u" 15u"
 - Bright Tin Plating (70-120u")
 - Bright Tin Plating (120u" Min).
 - No Plating Material
 - Fog Tin Plating
 - High temperature Tin

⑥ Color : Natural Color

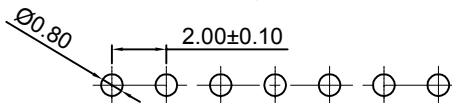
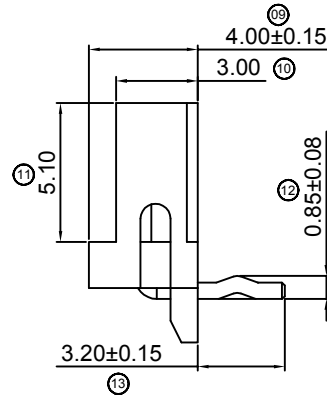
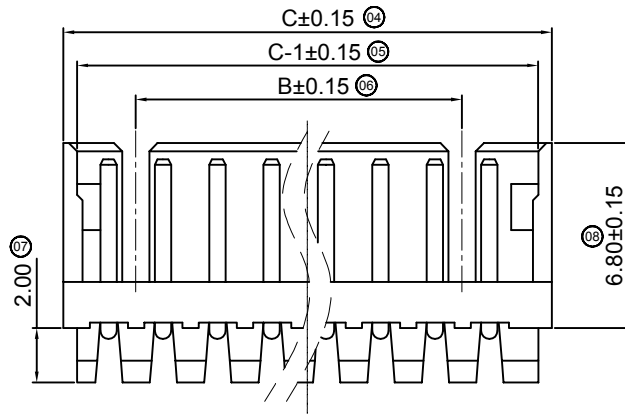

Recommended P.C.B Layout(Top Side)
P.C.B Thickness = 1.20mm (Tolerance=±0.05)

Poles	Dimensions (mm)		
	A	B	C
02	2.00		5.96
03	4.00		7.96
04	6.00	4.00	9.96
05	8.00	6.00	11.96
06	10.00	8.00	13.96
07	12.00	10.00	15.96
08	14.00	12.00	17.96
09	16.00	14.00	19.96
10	18.00	16.00	21.96
11	20.00	18.00	23.96
12	22.00	20.00	25.96
13	24.00	22.00	27.96
14	26.00	24.00	29.96
15	28.00	26.00	31.96

							GENERAL TOLERANCE X ±0.30 .XX ±0.20 .XXX ±0.10				东莞市翰皓精密电子有限公司 Dongguan HanHao Precision Electronics Co.,Ltd				PART NO. A2013WR-XX											
							APPROVAL Smark				CHECK Yu wei				DRAWN Liu Yan				DATA 2011/05/22							
							PROJECT 				UNIT mm				SCALE 1 : 1				NUMBER 8				REV B			
2011/05/22	A	B		Modify frame format	Jova	Jova Lau					TITLE 2.0 mm Crimp Style Connectors															
DATE	OLD REV	NEW REV	ECN	DESCRIPTION	CHECK	APPROVAL																				

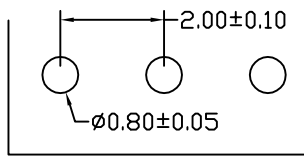
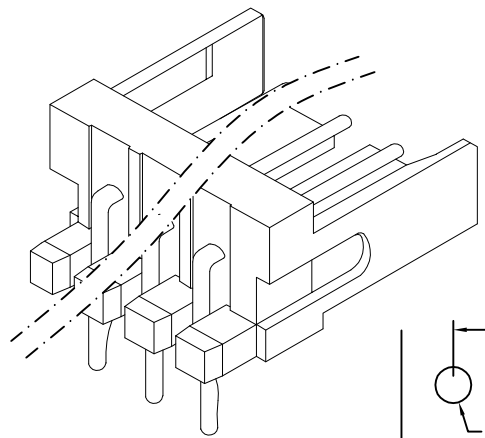
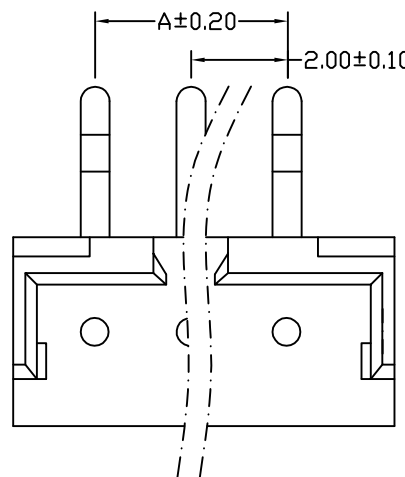

Specifications

- Voltage rating : 125V AC/DC
- Current rating : 4A AC/DC.
- Withstanding voltage : 1000V AC/Minute.
- Insulation resistance : 1000MΩ Min.
- Temperature range : - 25° ~ + 85°
- Contact resistance : Initial value/10mΩ Max.
- After environmental testing/20mΩ Max.

Wafer

- Part No. :A2013WRP
- Material : Base:Nylon 66 UL94V-0
- Pin : Brass/Tin-plated

P.C.B. LAYOUT

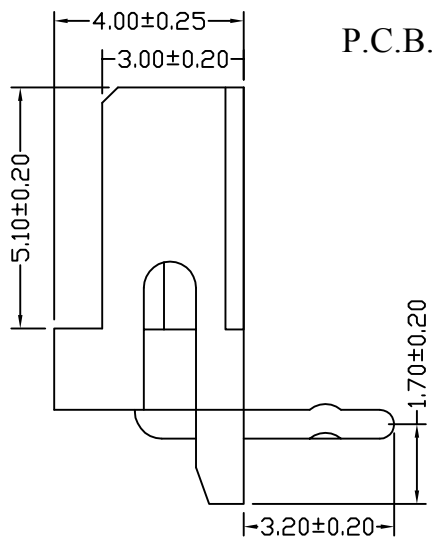
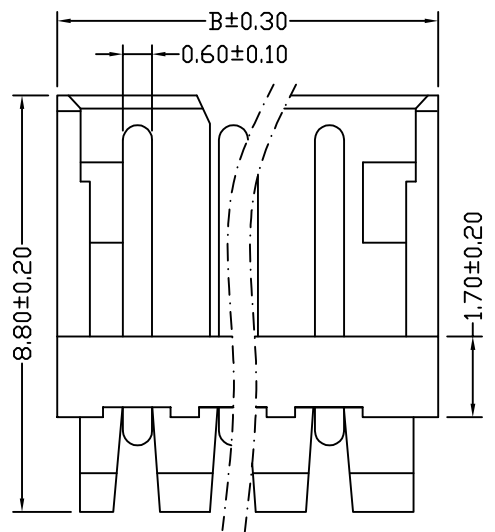

Poles	Part No	Dimensions (mm)	
		A	B
2	A2013WRP -02	2.00	5.96
3	A2013WRP -03	4.00	7.96
4	A2013WRP -04	6.00	9.96
5	A2013WRP -05	8.00	11.96
6	A2013WRP -06	10.00	13.96
7	A2013WRP -07	12.00	15.96
8	A2013WRP -08	14.00	17.96
9	A2013WRP -09	16.00	19.96
10	A2013WRP -10	18.00	21.96
11	A2013WRP -11	20.00	23.96
12	A2013WRP -12	22.00	25.96
13	A2013WRP -13	24.00	27.96
14	A2013WRP -14	26.00	29.96
15	A2013WRP -15	28.00	31.96

							GENERAL TOLERANCE X ±0.30 .XX ±0.20 .XXX ±0.10				东莞市翰皓精密电子有限公司 Dongguan HanHao Precision Electronics Co.,Ltd				PART NO. A2013WRP-XX											
							APPROVAL Smark				CHECK Yu wei				DRAWN Liu Yan				DATA 2011/05/22							
							PROJECT 				UNIT mm				SCALE 1:1				NUMBER 8				REV B			
2011/05/22		A	B	/	Modify frame format		Jova		Jova Lau																	
DATE	OLD REV	NEW REV	ECN	DESCRIPTION			CHECK	APPROVAL																		

1 2 3 4 5 6 7 8

F

F

E

E

D

D

C

C

B

B

A

A

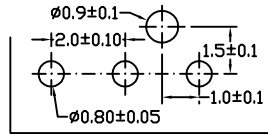
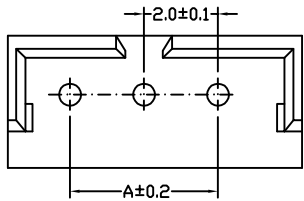

P.C.B. LAYOUT

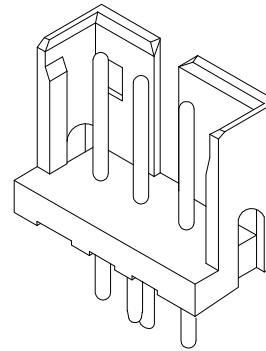

■ SPECIFICATIONS

- Voltage rating : 125V AC, DC
- Current rating : 4A AC,DC.
- Withstanding voltage : 1000V AC/minute
- Insulation resistance : 1000MΩ min.
- Temperature range : - 25° ~ + 85°
- Contact resistance : Initial value/10m Ω max.
- After environmental testing/20m Ω max.

■ WAFER

- Part No. : A2013WVD
- Poles : 02-15
- Material : Base:Nylon 66 UL94V-0
- Pin : Brass/Tin-plated

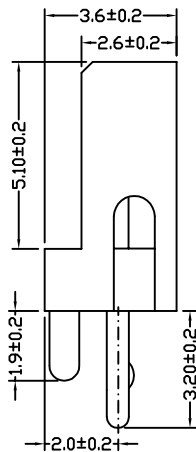
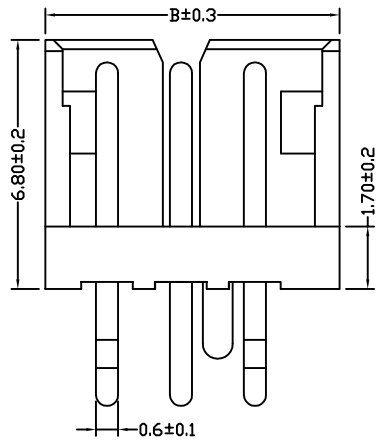

Poles	Part No	Dimensions (mm)	
		A	B
2	A2013WVD-02	2.00	5.85
3	A2013WVD-03	4.00	7.85
4	A2013WVD-04	6.00	9.85
5	A2013WVD-05	8.00	11.85
6	A2013WVD-06	10.00	13.85
7	A2013WVD-07	12.00	15.85
8	A2013WVD-08	14.00	17.85
9	A2013WVD-09	16.00	19.85
10	A2013WVD-10	18.00	21.85
11	A2013WVD-11	20.00	23.85
12	A2013WVD-12	22.00	25.85
13	A2013WVD-13	24.00	27.85
14	A2013WVD-14	26.00	29.85
15	A2013WVD-15	28.00	31.85

							GENERAL TOLERANCE		东莞市翰皓精密电子有限公司				PART NO. A2013WVD-XX			
							X ±0.30		Dongguan HanHao Precision Electronics Co.,Ltd				TITLE 2.0 mm Crimp Style Connectors			
							.XX ±0.20		APPROVAL Smark		CHECK Yu wei		DRAWN Liu Yan		DATA 2011/05/22	
							.XXX ±0.10		PROJECT				UNIT mm		SCALE 1:1	
2011/05/22	A	B		Modify frame format	Jova	Jova Lau	PROJECT						NUMBER 8		REV B	
DATE	OLD REV	NEW REV	ECN	DESCRIPTION	CHECK	APPROVAL	PROJECT									

1 2 3 4 5 6 7 8